

A reliable advanced cooling technology meets high density mounting for electronic applications.

Furukawa Electric has developed a high quality heat sink with built-in micro heat pipe (μ HP) for high density mounting and downsizing of electronic products. The micro heat pipe's excellent thermal performance accelerates the commercialization in many applications. Furukawa's leading edge technology supplied over 1,000,000 micro heat pipe heat sinks monthly.

NECESSITY OF μ HP-HS

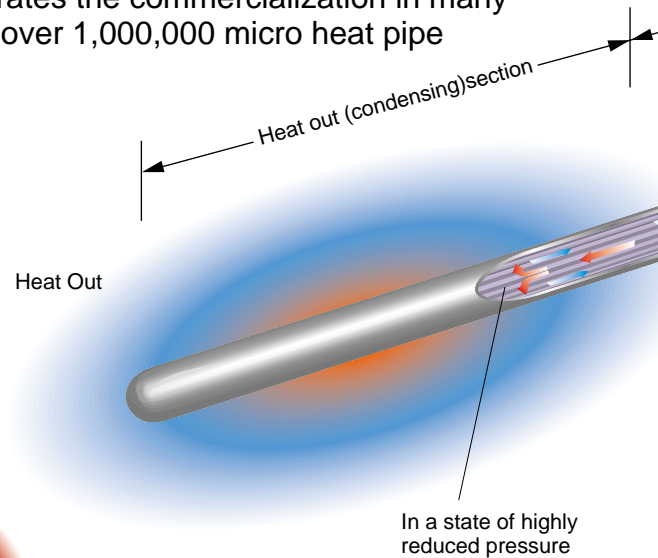
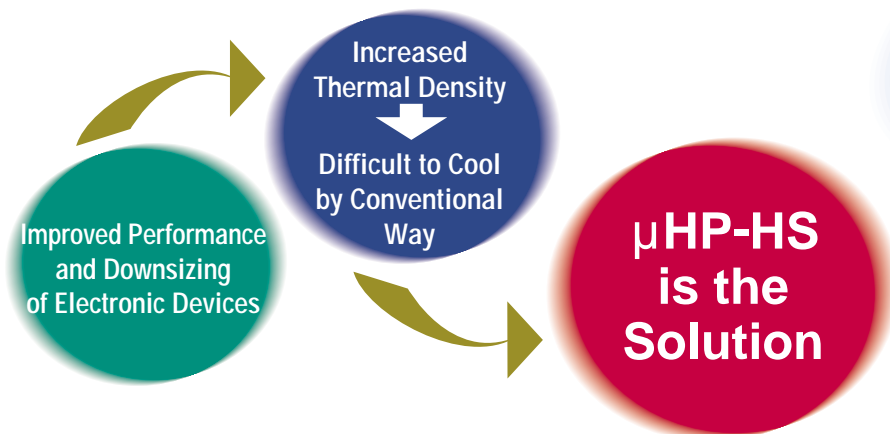

FEATURES

Excellent Performance

Quick Thermal Response
Compact and Light Weight

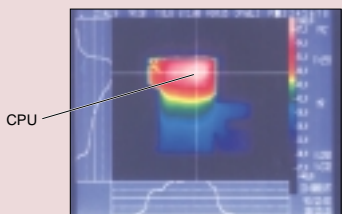
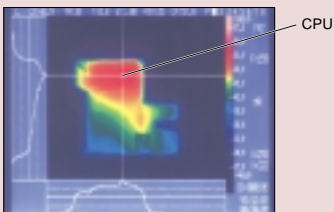

High Quality

Long Product Life
Used in Space Ship

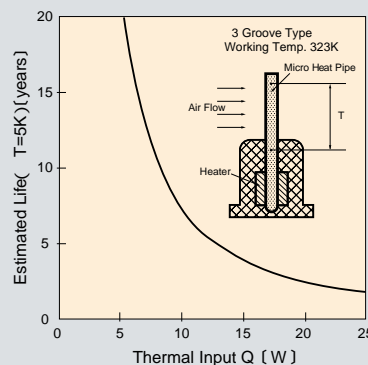

ESTIMATED LIFE OF Cu/water μ HP (Based on Accelerated Test)

Large Capacity

Low Cost

Made in JAPAN, USA and TAIWAN
fast delivery

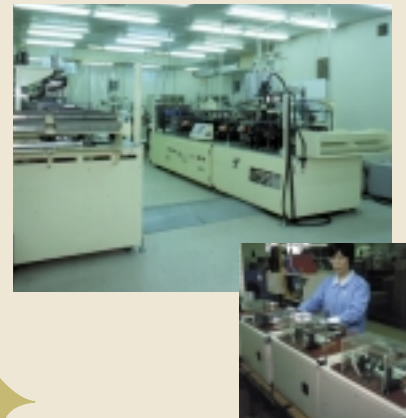

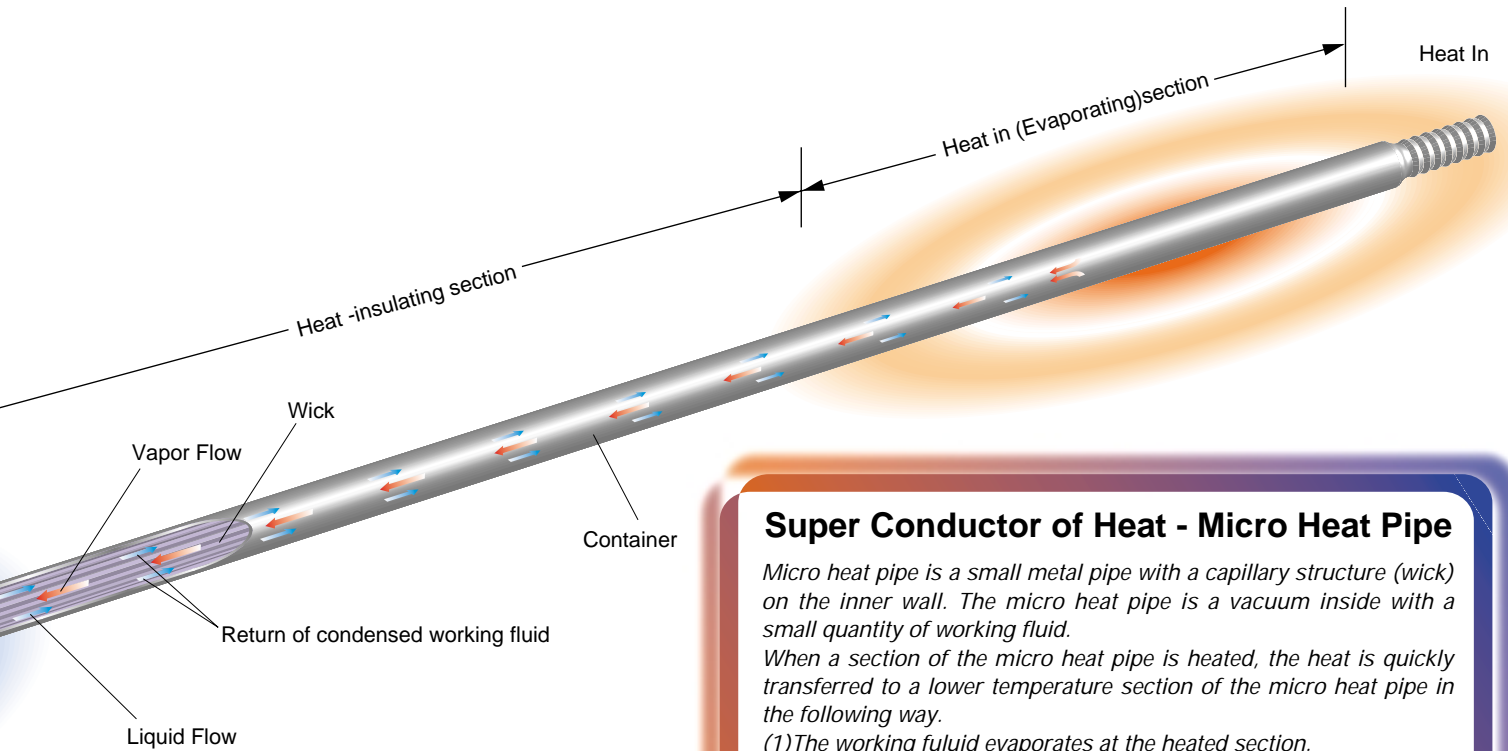

Super Conductor of Heat - Micro Heat Pipe

Micro heat pipe is a small metal pipe with a capillary structure (wick) on the inner wall. The micro heat pipe is a vacuum inside with a small quantity of working fluid.

When a section of the micro heat pipe is heated, the heat is quickly transferred to a lower temperature section of the micro heat pipe in the following way.

- (1) The working fluid evaporates at the heated section. (absorption of latent heat)
- (2) The vapor moves to the lower temperature section.
- (3) The vapor condenses in the lower temperature section. (discharge of latent heat)
- (4) The condensed working fluid flows back to the heated section through capillary action.

The micro heat pipe is a super conductor of heat for micro device cooling. The micro heat pipe offers increased downsizing and improved performance for all electronic devices.



Mesh wick



Terminal form

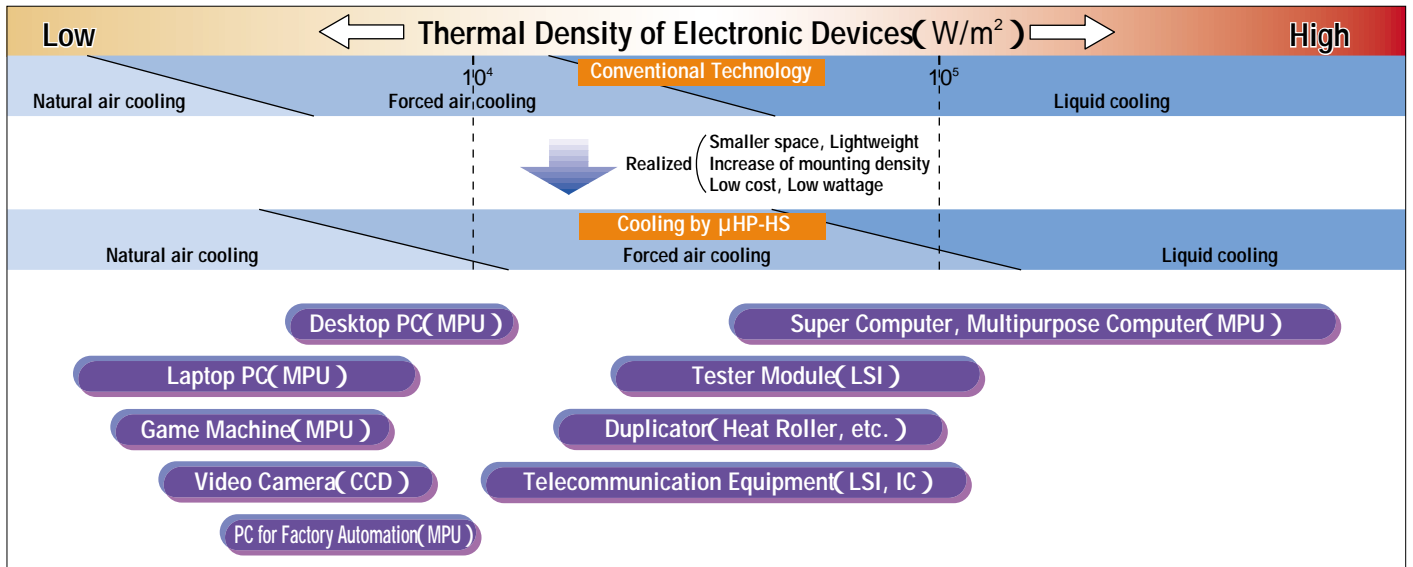

FURUKAWA'S Heat Pipe Technology

Furukawa has been offering heat pipe products to many fields for more than 20 years. Furukawa has been keeping top share of heat pipe products, supported by its technology and reliability.

Main Use

- Power Electronics
- Electric Train
- Air Conditioning (Rooftop Heating)
- Aerospace etc.



APPLICATION EXAMPLES OF μ HP-HS

Application to Laptop PC

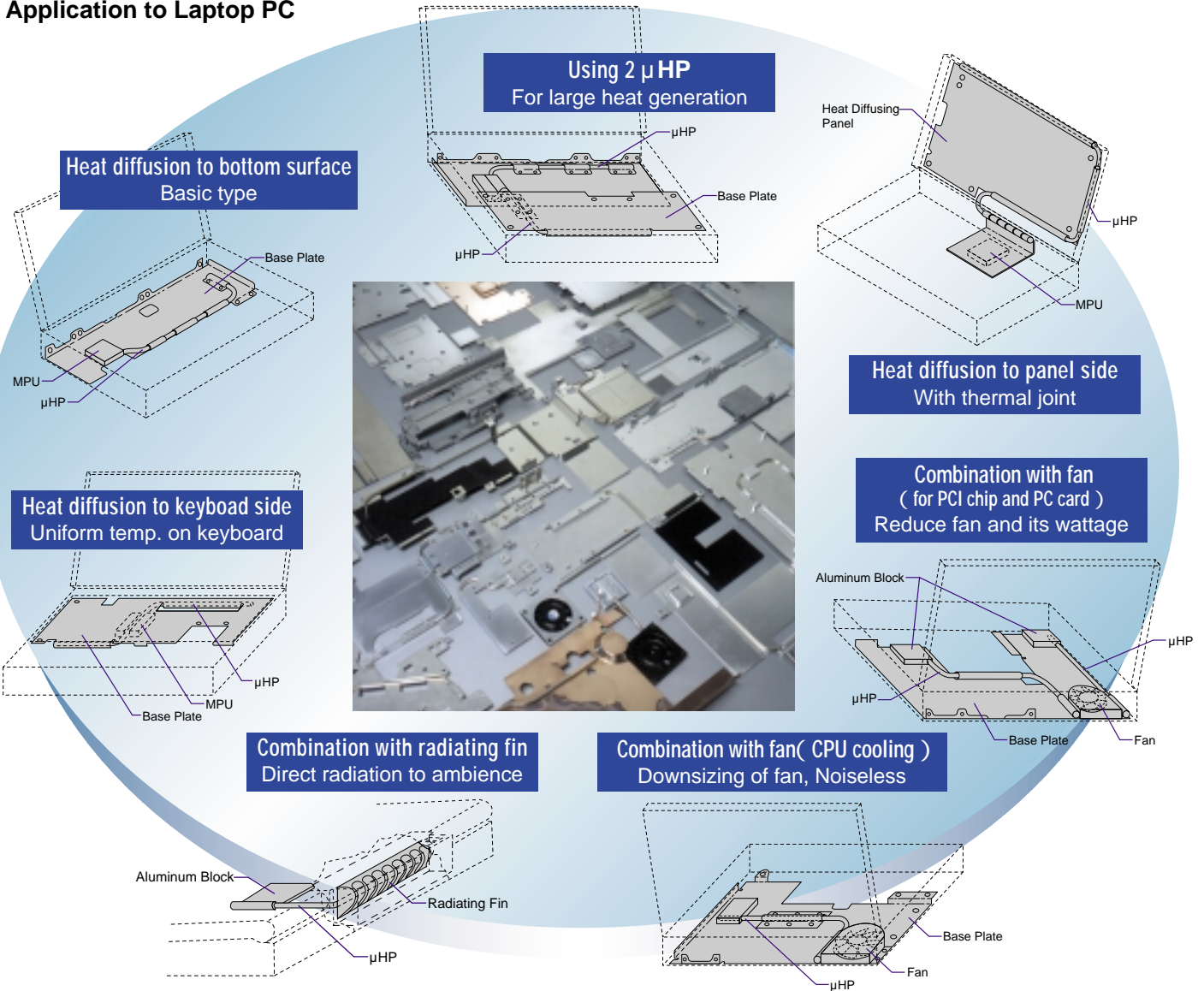

Application to Desktop PC

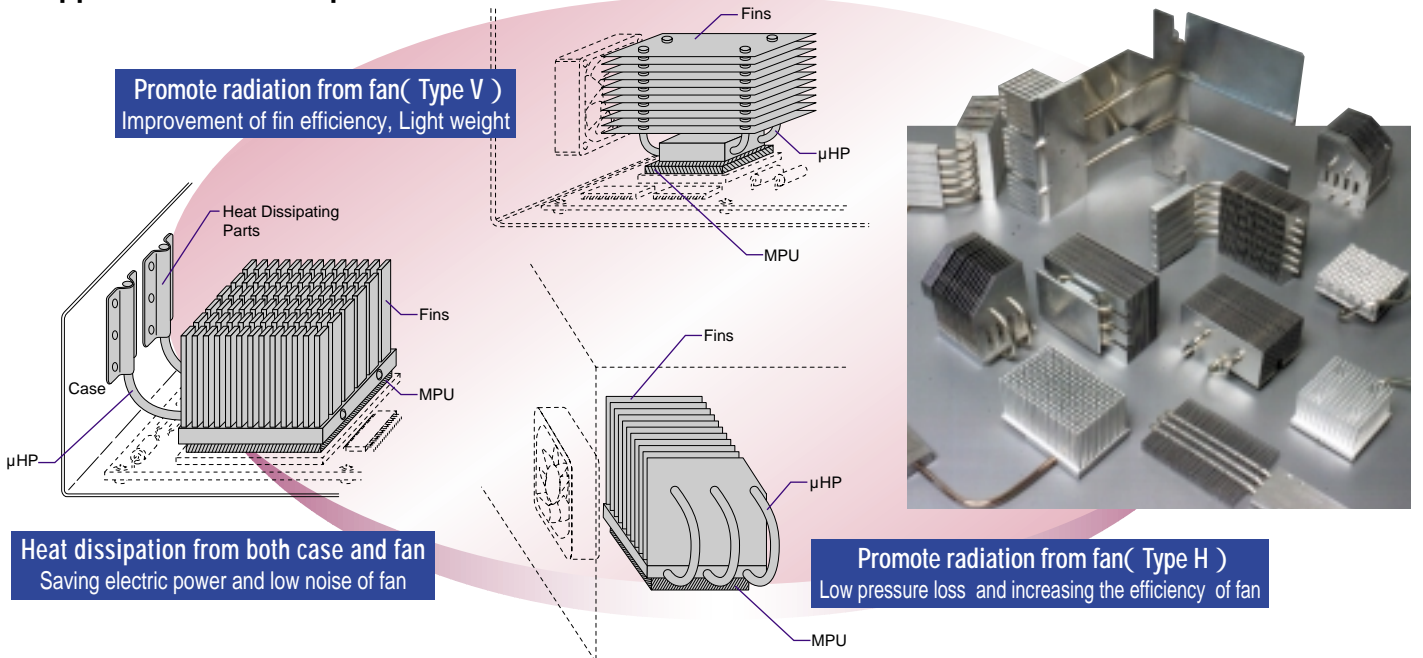

Furukawa's Micro Heat Pipe Heat Sinks, supported by heat pipe technology and cooling technology which have been cultivated for more than 20 years, is already in use in various electronic applications. Please contact Furukawa for a thermal solution for your application.

For Telecommunication and Others

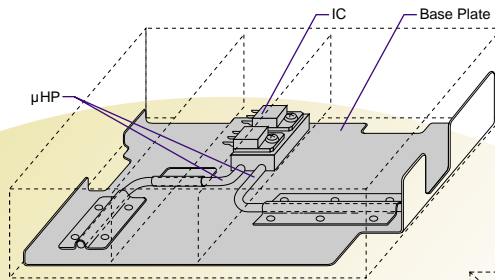

**Satellite communication device
Fanless**

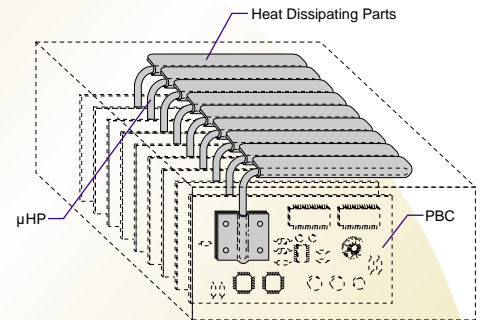

**Opt-electronic Device
Heat diffusion to chassis**

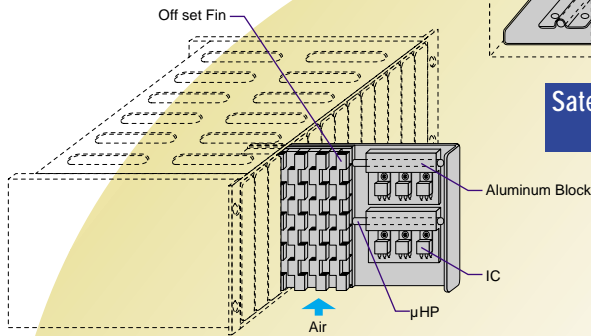

**Telecommunication Converter
Realize narrow pitch of circuit board**

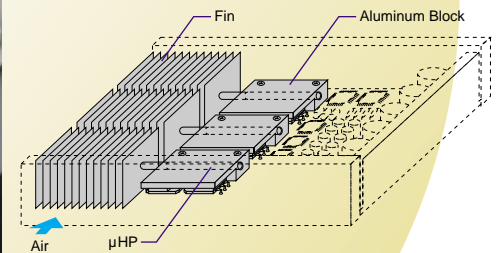
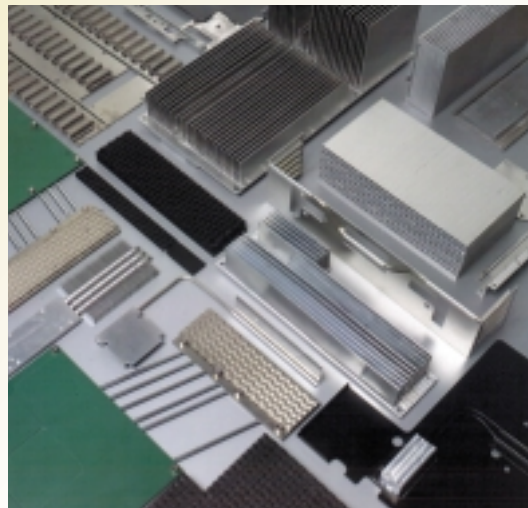

**Server
for large heat generation**

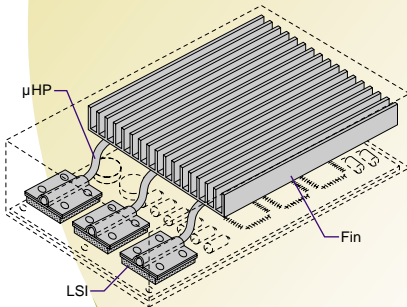

**Evaluating System for semi-conductors
Realize air cooling**

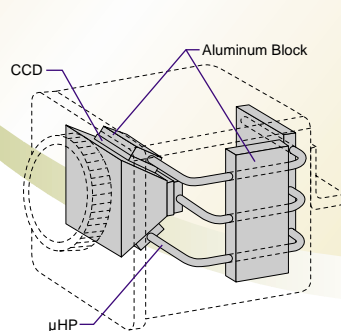

**Video Camera
Replacing thermal wiring**

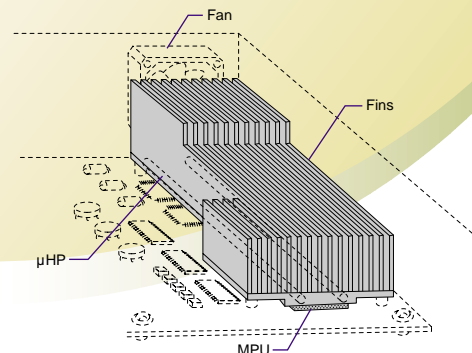

**Workstation
realize low noise**

μ HP-HS can also apply to many other uses, not only above examples.
 Duplicator, Game machine, Automobile, Small size motor, Medical, Dies, others.

μHP-HS COMMERCIALIZATION

Furukawa's Micro Heat Pipe Heat Sinks are manufactured in compliance with each customer's specific design. Furukawa welcomes the opportunity to assist in your thermal design solution using the latest cooling technologies. Various inspections in the volume production guarantee the highest quality in Furukawa's products.

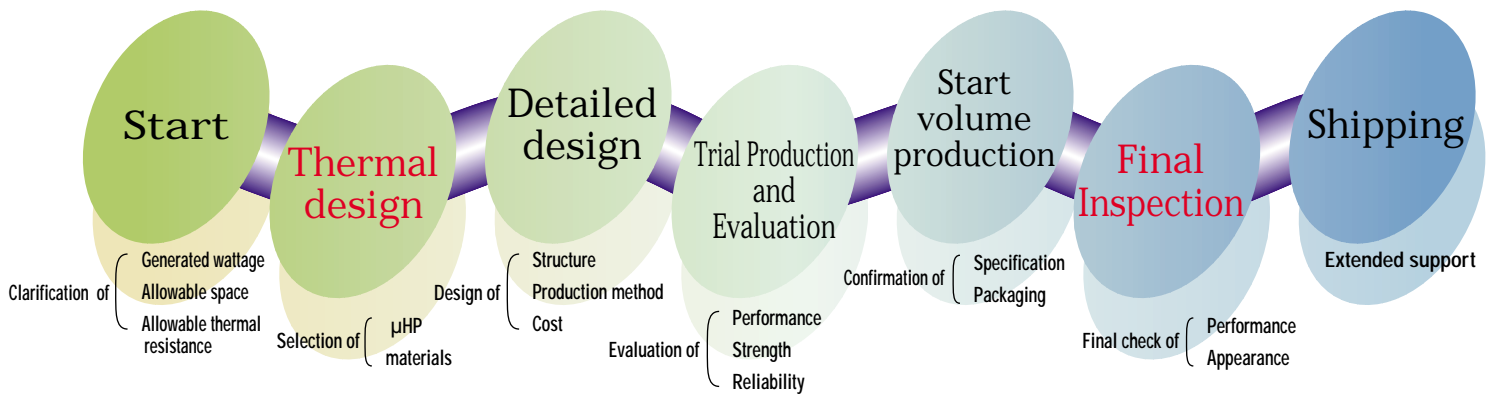

μHP Standard Dimensions

(unit:mm)

Designation	O.D. (D or 2×B)	Length* (A)	Minimum Radius (R)
CW02G-R	2	100	7
CW03G-R	3	150	11.5
CW03G-F	2×3.7	200	
CW04G-R	4	250	14
CW04G-F	2×5.3	300	16
CW06G-R	6	350	27
CW06G-F	2×8.5	400	32

*Other sizes except above is available as special order

Standard Form and Typical Modification

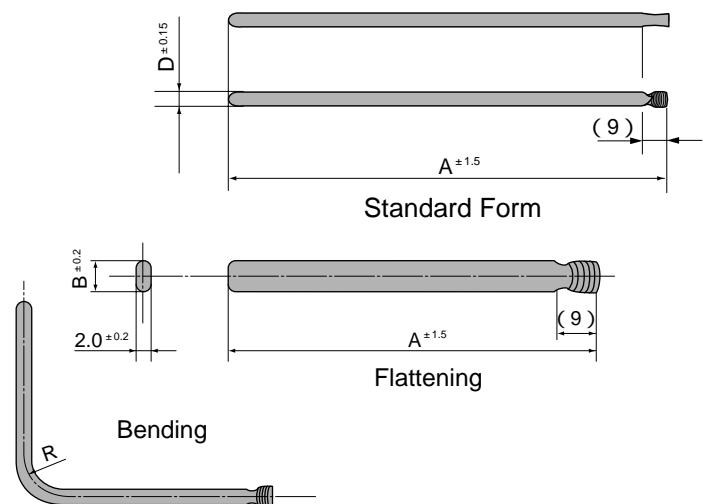

Thermal Performance of μHP

Maximum heat transfer rate

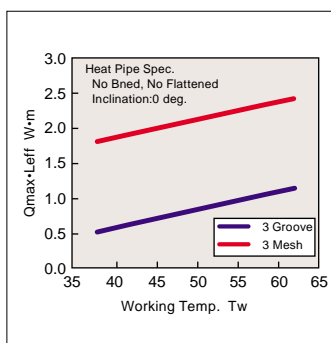

Thermal Resistance

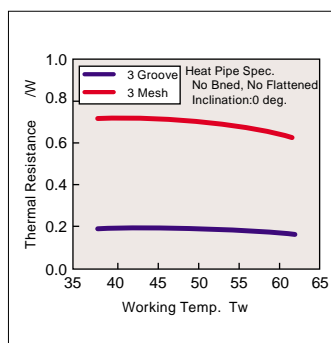

Actual thermal performance of μ HP-HS depends on its specification.

Thermal Radiation Parts

Various thermal radiation parts are available.

Plates.....Aluminum, Copper, Die cast etc.

Fins

Off set fins

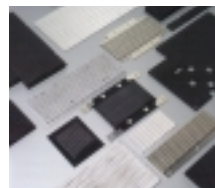

Ladder fins

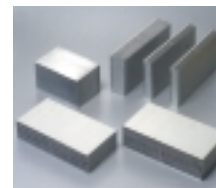

Folded fins

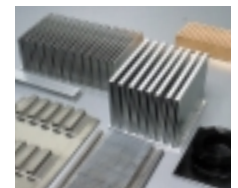

Other fins in addition to above are available.

Others.....Fan,Peltier elements,Cold plate etc.

FURUKAWA'S THERMAL TECHNOLOGY SUPPORT

Furukawa has been supplying superior performance and high quality products, through a variety of tests and evaluations performed by our engineering staff. Furukawa utilizes the latest technologies, thermal evaluation, numerical analysis, etc, to assist in your development of new products and thermal solution.



Yokohama R&D Laboratories

Evaluation of Reliability



Evaluation of Performance

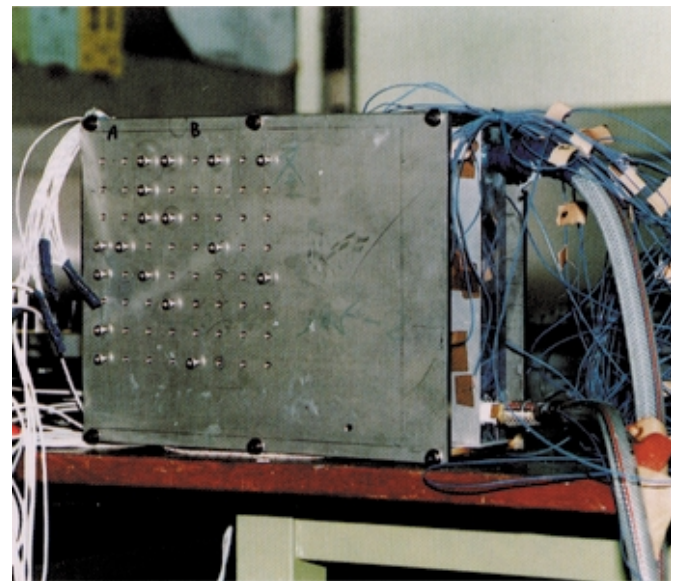

Numerical Analysis

Analysis of cooling effect by using μ HP

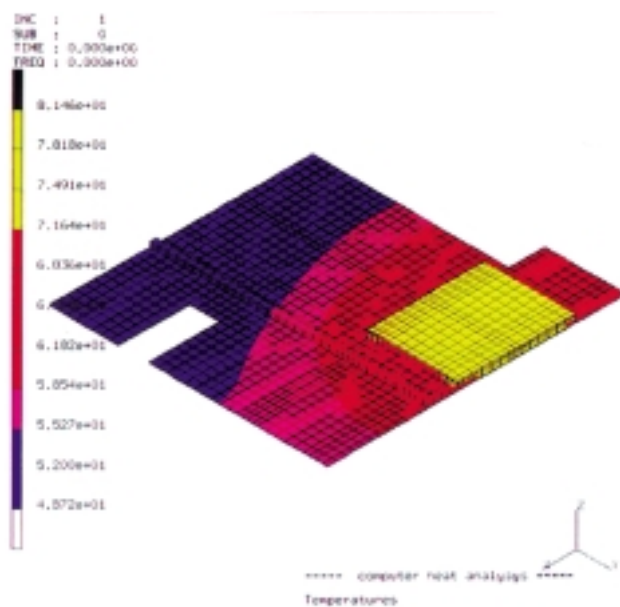

No μ HP mounted

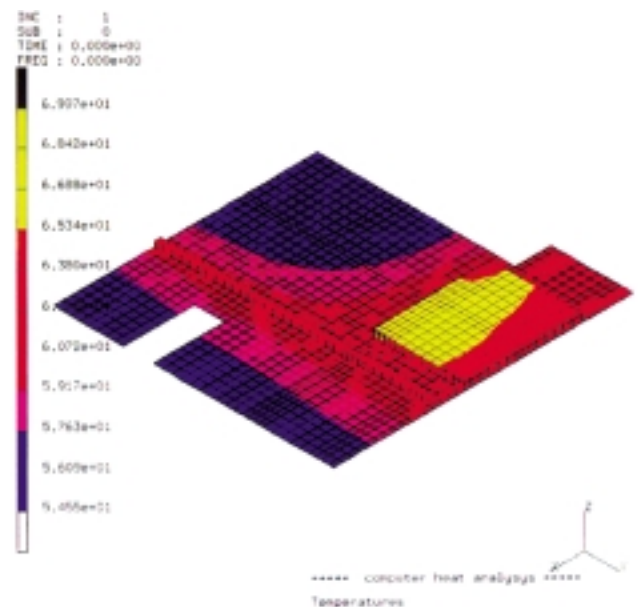

μ HP mounted