

Development of an External Laser Source for Co-Packaged Optics

*Taketsugu Sawamura^{*1}, Kazuhiko Kashima^{*1}, Kyoko Nagai^{*1}, Daiki Takeda^{*1},
Tsunetoshi Saito^{*1}, Kouhei Umeta^{*1}, Masayoshi Kimura^{*2}, Hideyuki Nasu^{*1},
Nitidet Thudsalingkarnsakul^{*3}, Rattanaporn Suksomboon^{*3}, Sanguan Anantathanasarn^{*3}*

ABSTRACT

We designed and fabricated an external laser source (ELS) for a network switch equipment employing the Co-Packaged Optics (CPO). This ELS integrates a newly developed uncooled 8-channel Transmitter Optical Sub-Assembly (TOSA) and a control circuitries into a Quad Small Form Pluggable (QSFP) housing, widely employed for optical transceivers. In order to obtain a high fiber-coupled power with low power consumption, we employed our high-power Distributed-Feed Back (DFB) laser diode, and we designed a heat dissipation structure and an optical system, a power-saving control circuitries. At a housing temperature of 55°C, the ELS achieved an optical fiber-coupled power of 20 dBm with power consumption of 5.6 W and power conversion efficiency (PCE) of 14.3% which is the best in the industry. The ELS achieved Polarization extinction ratio (PER) of >20 dB and Side-Mode Suppression Ratio (SMSR) of >50 dB respectively.

1. INTRODUCTION

To support a lot of kinds of IT services, such as cloud services and 5G mobile networks, machine learning, Artificial Intelligence (AI), the volume of network traffic has been growing explosively and high-speed data processing in data centers becomes more important. In data centers, the network switch devices take a bigger role and their transmission capacity depends on the performance of a switch Application Specific Integrated Circuit (ASIC). Since 2010, the bandwidth of a switch ASIC has doubled in two years and reached to 51.2 Tbps in 2022¹⁾. The existing network switch equipment consists of optical transceivers which are operated at the front panel, hence the electrical transmission path between an optical transceiver and a switch ASIC is long and transmission loss becomes high. In order to realize wide bandwidth, power hungry electronic devices which regenerate and shape the degraded signal during electrical transmission are necessary in existing network equipment.

For the reason above, adoption of CPO which can replace some electrical paths to optical paths in the network switch equipment is expected. Figure 1 shows a schematic illustration of the CPO. Since tiny optical transceivers are mounted together with a switch ASIC and on

same substrate, an electrical transmission path between the optical transceiver and the switch ASIC can be significantly shorter to <50 mm and transmission loss can be improved. Therefore, power hungry electronic devices which compensates electric signal degradation can be eliminated and the power consumption of the optical transceiver can be reduced. Although the temperature increase of the optical transceiver itself is suppressed by the reduction of power consumption, the switch ASIC generates a large amount of heat due to its large power consumption and it derives temperature increase of optical transceivers mounted near a switch ASIC. For a compound semiconductor laser, it is difficult to keep characteristics and the reliability in high ambient temperature environment. Hence, an external laser source (ELS) which is placed at a front panel in an environmental condition of lower ambient temperature is proposed. And an ELS integrates a number of lasers into a pluggable small form factor (SFF).

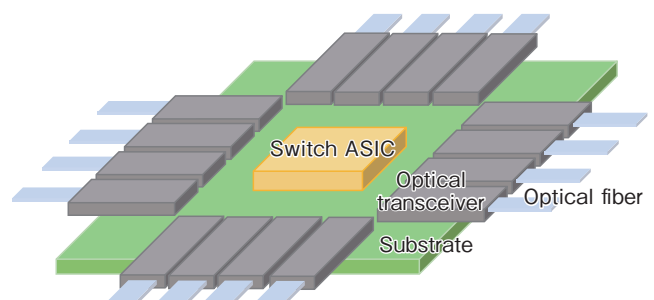

Figure 1 Schematic illustration of the CPO.

^{*1} Photonics-Electronics Convergence Department, Photonics Laboratories

^{*2} Photonic Devices Department, Photonics Laboratories

^{*3} Furukawa FITEL (Thailand)

We designed and fabricated an ELS for the CPO, which employed a QSFP housing widely employed in the optical transceiver, and a newly developed uncooled 8-channel TOSA and control circuitries. In this paper we report designs and characteristics of this ELS, which achieves a fiber-coupled power of 20 dBm with power consumption of 5.6 W and record PCE of 14.3% at a housing temperature of 55°C.

2. EXTERNAL LASER SOURCE FOR THE CPO AND ITS DEVELOPMENT GOALS

As the guidance and specifications of an ELS for CPO, ELS guidance document²⁾ and ELSFP Implementation Agreement³⁾ have been published by the CPO Collaboration and the Optical Internetworking Forum (OIF). The proposed Small Form Factors (SFFs) are a QSFP-DD and an Octal Small Form-factor Pluggable (OSFP) which are adopted for optical transceivers, and an External Laser Small Form Factor Pluggable (ELSFP) which is a newly proposed form factor for an ELS. The ELS has several optical outputs in compliant with 400GBASE-FR4 or 400GBASE-DR4, which requires the wavelength allocation of 4-wavelength Coarse Wavelength Division Multiplexing (CWDM) (i.e., 1271 nm, 1291 nm, 1311 nm, 1331 nm) or single wavelength of 1311 nm. And the ELS is required a high fiber-coupled power with low power consumption and high PCE, hence uncooled laser structure which doesn't consist of a Thermo-Electric Cooler (TEC) to cool laser diodes is preferable. J. E. Johnson et al. reported uncooled 8-channel ELS using with a double-height QSFP-DD housing. The fiber-coupled power of this ELS achieved 20 dBm at housing temperature of 50°C, and power consumption was 8.0 W, and power conversion efficiency was 10%⁴⁾.

This time, we designed and fabricated a compact uncooled 8-channel TOSA which can be built together with control circuitries in all housings proposed for an ELS housings that have been proposed. And we designed and fabricated an ELS employing a QSFP housing which is the smallest among proposed housings for an ELS. The target characteristics is optical output power of 20 dBm for all channels at a housing temperature of 55°C with power consumption of <6.5 W.

3. DESIGN OF 8-CHANNEL TOSA

Figure 2 shows schematic internal layouts of a QSFP ELS, an OSFP ELS and an ELSFP. The target size of an 8-channel TOSA is as small as 22.5 mm (L) x 13.0 mm (W) x 4.0 mm (H) which can be built in each housing. The TOSA is electrically connected to the control circuitries through a flexible printed circuit (FPC). Since the laser beam from the ELS is modulated by a silicon photonics modulator of an optical transceiver. Therefore, a polarization maintaining fiber (PMF) is employed to transmit linearly polarized beam. For the LD, in order to obtain a

fiber-coupled power of 20 dBm without a TEC, our high-power DFB-LD⁵⁾ is employed. The temperature of the substrate where each LD is mounted is defined as a case temperature. To guarantee the reliability of each LD under the operating conditions of a case temperature of 55°C and an optical output power of 20 dBm, a TOSA structure is designed to keep a LD temperature <65°C. Furthermore, a coupling efficiency between the LD and an optical fiber is targeted as >75% and a LD bias current to obtain fiber-coupled power of 20 dBm is targeted as <350 mA, based on an optical output power characteristics of the LD.

First, to design a pitch size to mount LDs, the relationship between the pitch size and the laser temperature is calculated by thermal simulations. The calculated results are shown in Figure 3. If the pitch size is narrow, the LD temperature increase by heat from adjacent LDs and the LD temperature decreases when the pitch is wider and saturated from the pitch size of 1.2 mm. From these

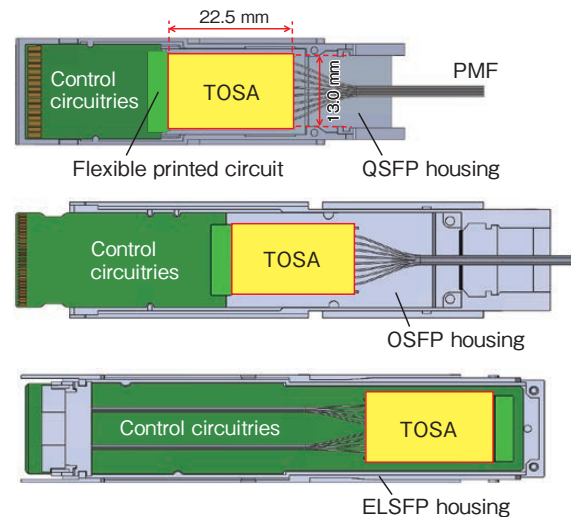

Figure 2 Internal layouts of ELSs employing QSFP, OSFP and ELSFP.

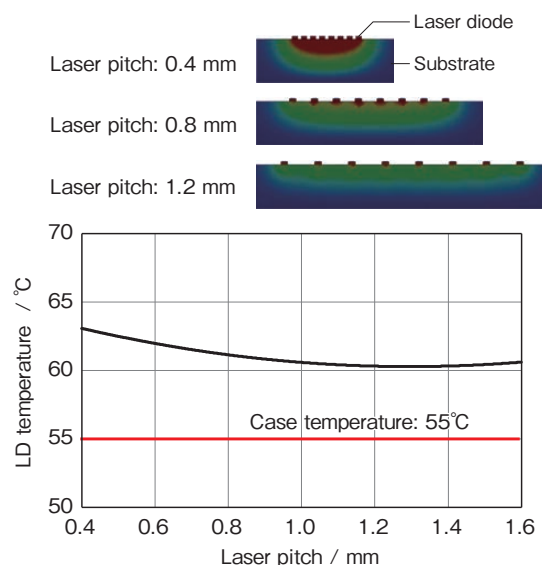

Figure 3 Calculated LD temperature as a function of the pitch size between DFB-LDs.

results, 1.2 mm is employed to suppress the LD temperature increase and to realize target width of 13.0 mm for TOSA. The relationship between LD bias current and LD temperature is also calculated by thermal simulations. The results are shown in Figure 4. When the LD bias current is 350 mA, the LD temperature increase is approximately 6°C from a case temperature of 55°C, the LD temperature rises to 61°C. To meet the target LD temperature of <65°C, the upper limit of the LD bias current should be 550 mA.

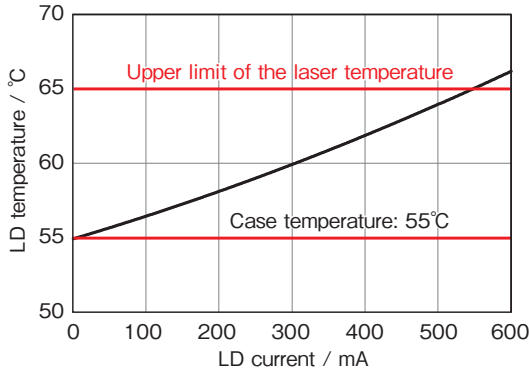

Figure 4 Simulated LD temperature as a function of LD bias current.

Figure 5 shows a schematic top view for the TOSA structure. Eight LDs are mounted on a substrate of the TOSA with 1.2 mm pitch and photodiodes (PDs) are also mounted on the substrate to monitor optical output power launched from back facets of the LDs. A laser beam launched from a front facet of the LD is coupled to a PMF through a focusing lens and an optical isolator. An optical isolator is employed to avoid unwanted optical reflection for the LD. A PMF is aligned and fixed to obtain high optical output power and PER. And when a case temperature changes from 25°C to 55°C, the deformation of the TOSA and the displacement of the optical fiber are calculated by thermal stress simulation, and an optical power change by the optical fiber displacement are calculated. Figure 6 shows the simulated 3D model of TOSA deformation when the TOSA case temperature changes from 25°C to 55°C. The aluminum cover, which prevents contamination and dust for optical system, is slightly deformed approximately 3 μm. Displacement of the optical fiber is as small as approximately 0.2 μm. Figure 7 shows optical power change as a function of optical axis displacement. As can be seen from Figure. 5, the axis displacement of 0.2 μm generates small degradation of optical power change. The estimated optical power degradation is less than 1%. Therefore, with this structure and optical system, an optical coupling efficiency can be consistent regardless of the TOSA case temperature.

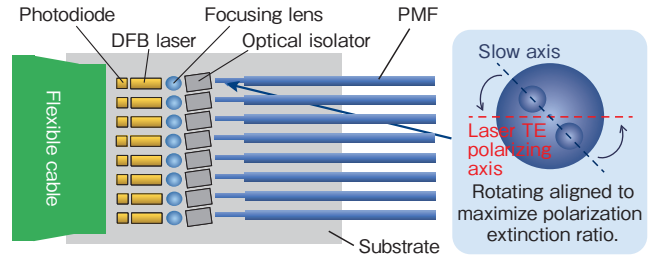

Figure 5 Schematic top view for the TOSA structure.

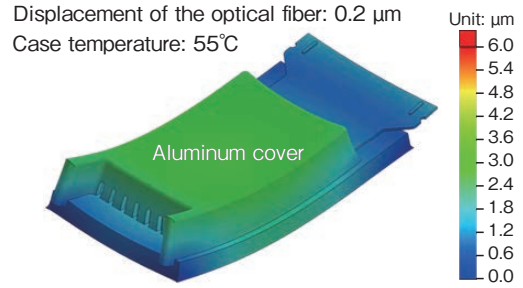

Figure 6 3D model of the TOSA deformed in thermal stress simulation.

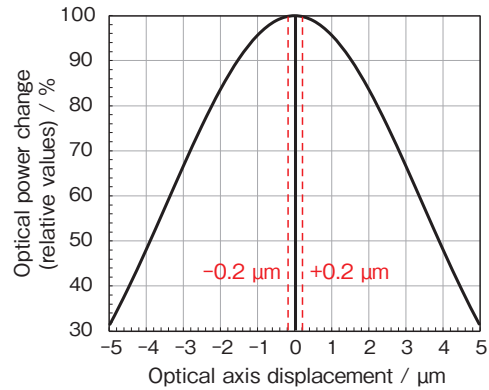

Figure 7 Optical power change as a function of optical axis displacement.

4. CHARACTERISTICS OF 8-CHANNEL TOSA

Figure 8 shows a photograph of the 8-channel TOSA. At the left edge of the substrate, the FPC is attached to connect to the each LD and PD. At the right edge of the substrate, 8-PMF cables are taken out through the aluminum cover of TOSA.

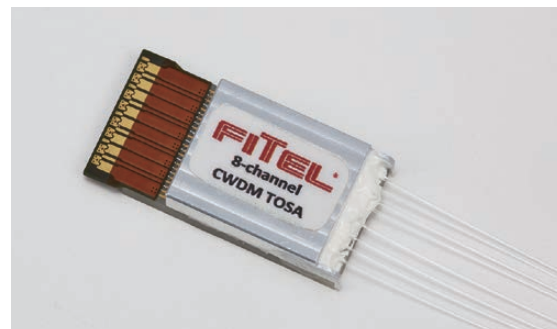

Figure 8 Photograph of the 8-channel TOSA.

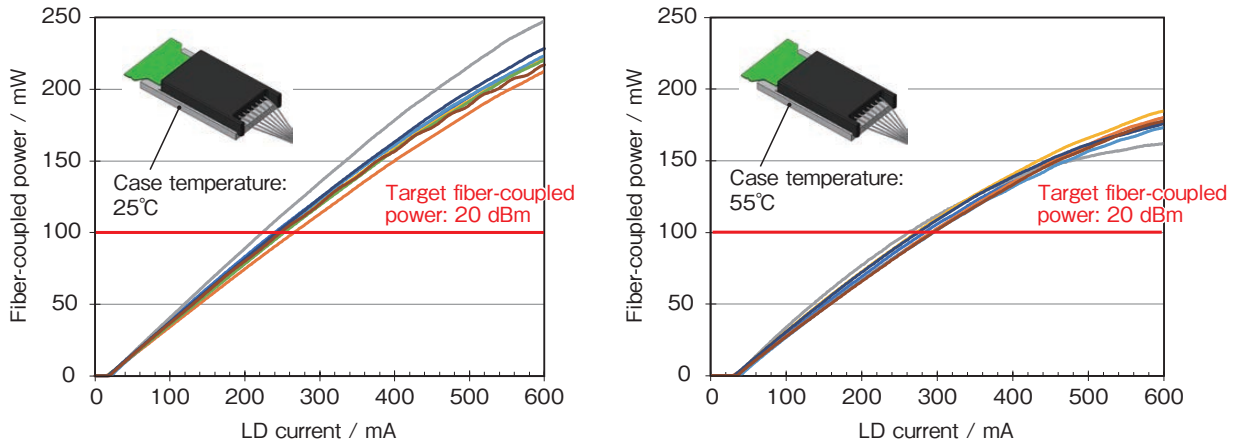

Figure 9 Optical power characteristics as a function of LD bias current and at the case temperatures of 25°C and 55°C.

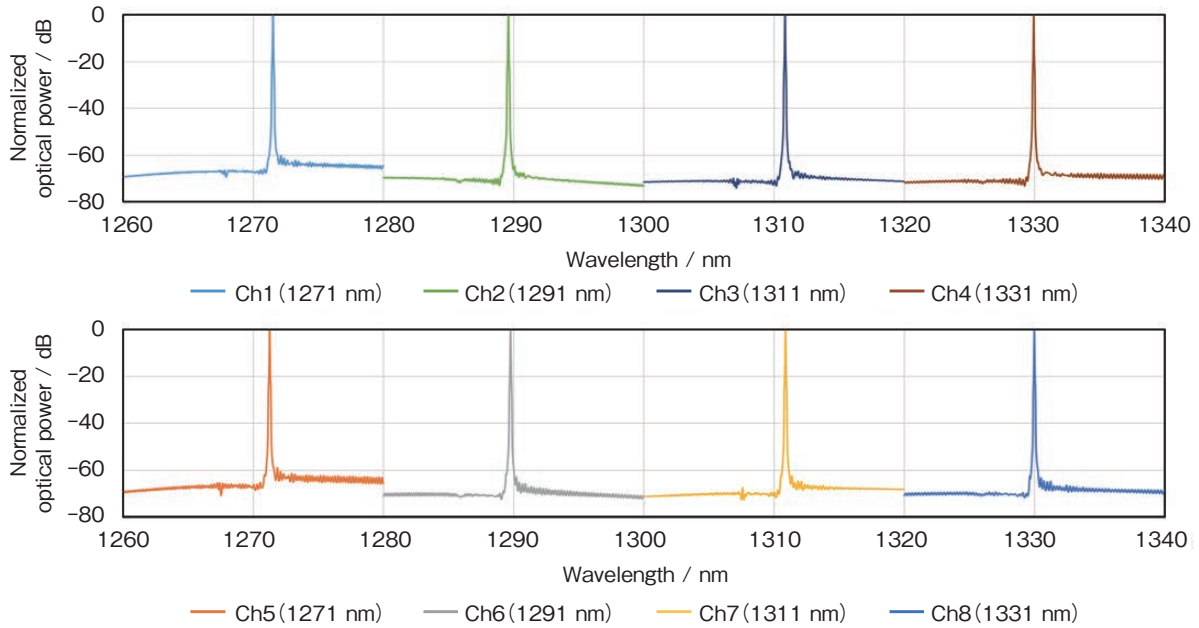

Figure 10 Measured optical spectra of the 8-channel TOSA.

Figure 9 shows the optical power characteristics for all 8 channels as function of LD bias current at the case temperature of 25°C and 55°C. The coupling efficiency is consistent as 80% - 85% regardless of the case temperature. Therefore, the LD bias current to obtain a fiber-coupled power of 20 dBm at the case temperatures of 25°C and 55°C were <300 mA, which is lower than the estimated 350 mA. This TOSA also achieves a fiber-coupled power of 20 dBm for all channels at a case temperature of 55°C and the power consumption measures as low as 3.7 W. Accordingly, power conversion efficiency of the TOSA achieves 21.2% which is the maximum value in the industry. Figure 10 shows the measured optical spectra for all channels. All the lasing wavelengths meet the wavelength requirements of CWDM 4⁶⁾. Measured side-mode suppression ratio (SMSR) numbers are >50 dB for all channels.

5. DESIGN OF PIGTAILED-QSFP ELS

Figure 11 shows a schematic illustration for a pigtailed QSFP ELS. The PMF cables are passed into a jacket together with a tension member (aramid fiber) to keep tensile strength and a 12-lane MPO connector is attached at the end of the PMF cables. It is important that the optical axes of PMF inside the MPO ferrule are aligned with each other so that linear polarization can be maintained at the connection of the MPO connectors. Figure 11 shows a schematic illustration for a definition of rotational angle error too. As can be seen in the figure, the target line is set to pass through the center of the guide pin. And the alignment line is set to pass through the individual center of two stress applying parts and the center of core. Each PMF is rotated and fixed so that the alignment line overlaps the target line by a visual observation. A rotational angle error is defined as an angular difference between the alignment line and the target line, and it is targeted as ± 3 degrees.

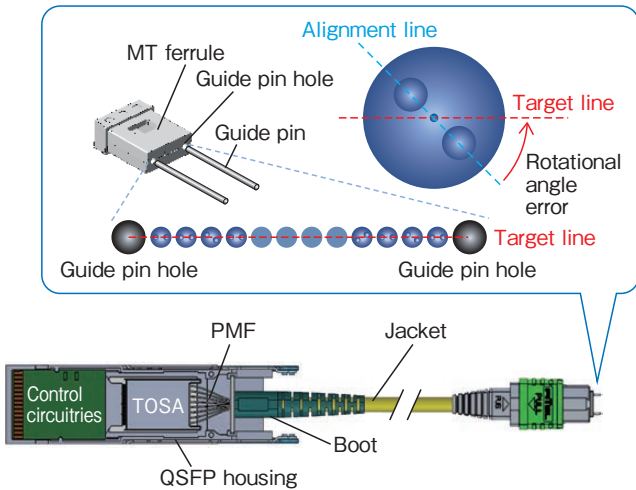

Figure 11 Schematic illustration for a pigtailed-QSFP ELS.

Figure 12 shows the block diagram for control circuitries. The control circuitries consist of a power supply regulator, a Micro Control Unit (MCU), LD control circuitries, and a temperature sensor. Since the electric power supply voltage for the ELS is 3.3 V, The LD control circuitries employ DC/DC converters. To save the power consumption, the DC/DC converters reduce a supply voltage of 3.3 V to the maximum LD bias voltage, which enables injecting an LD bias current of 500 mA sufficiently.

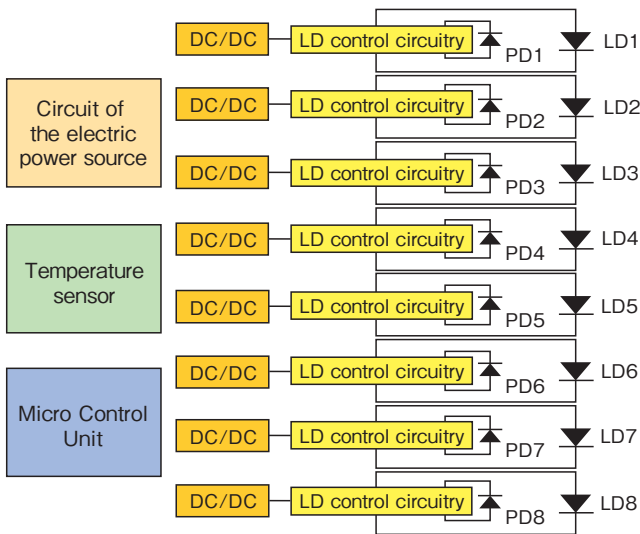

Figure 12 Block diagram for the control circuitries.

With this control circuitries, each LD can be operated on Auto Current Control (ACC) mode or Auto Power Control (APC) mode, and the optical output power of each channel, internal temperature of the housing, and current and voltage of each laser diode and electric power source can be monitored through the Inter Integrated Circuit (I2C) interface.

Figure 13 shows the cross-sectional view of the pigtailed-QSFP ELS in an air-cooling environment. When the pigtailed-QSFP ELS is inserted into a cage which has an air-cooling heat sink at a top, the top surface of the QSFP

housing is thermally connected to the air-cooling heat sink. Hence, the heat inside the housing is transferred to the air-cooled heat sink through the upper side of the housing and dissipated. Therefore, we define that the ELS's housing temperature is the surface temperature of the top housing. In order to drive the TOSA inside the QSFP housing without degrading TOSA's characteristics, it is important to minimize the difference between the housing temperature and the TOSA case temperature. Therefore, it is much preferable to attach the bottom surface of TOSA on the top housing so that the thermal resistance is minimize. Figure 14 shows the temperature distributions inside the QSFP housing while all channels are driving at LD bias current of 300 mA and housing temperature of 55°C in thermal simulation. The increase of TOSA case temperature is calculated as low as about 0.7°C. By adopting a highly efficient heat dissipation structure in which the bottom substrate of TOSA is mounted on the top housing, a temperature increase of TOSA inside the housing is suppressed as low as 1.4°C.

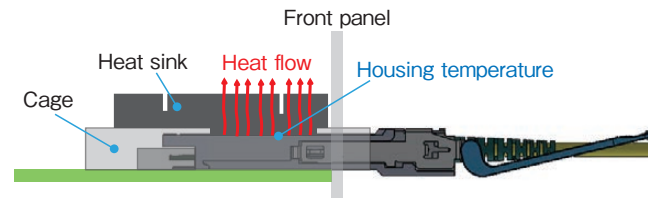

Figure 13 Driving environment of the QSFP ELS.

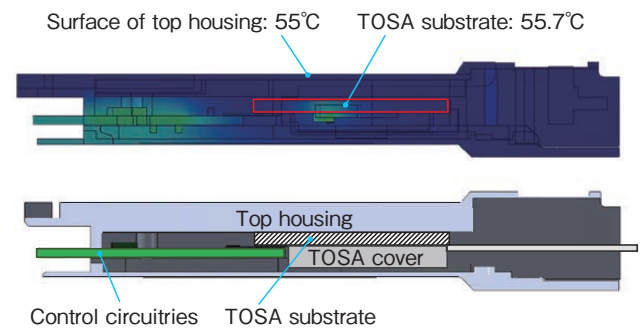

Figure 14 Cross-sectional view of a simulated temperature distributions inside the QSFP housing.

6. CHARACTERISTICS OF PIGTAILED-QSFP ELS

Figure 15 shows photographs of a fabricated pigtailed-QSFP ELS. The TOSA and the control circuitries are built in the QSFP housing as designed and the 12-core MPO connector is attached at the end of the PMF cables. Figure 16 shows photographs of PMF end face at the MT ferrule. As shown in Table 1, each cable can be assembled in good accuracy as the rotational angle error of ± 2 degrees. Furthermore measured PER numbers are >20 dB for all 8 channels.

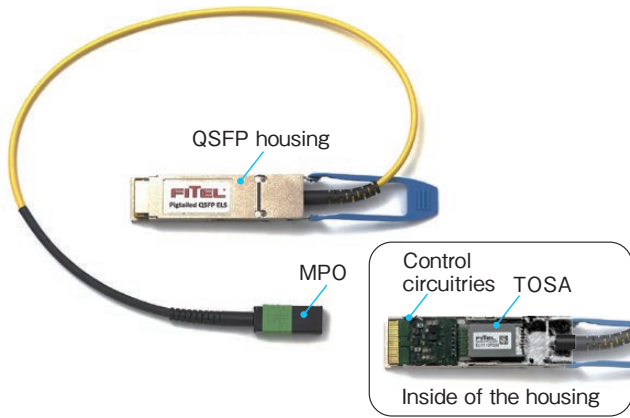

Figure 15 Photograph of the pigtailed-QSFP ELS.

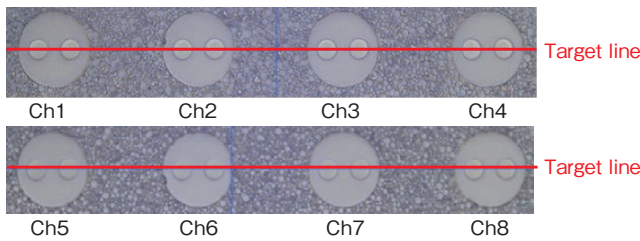

Figure 16 Photographs of an end face of the MT ferrule.

Table 1 Measured PER and rotational angle error for each channel.

Item	Ch1	Ch2	Ch3	Ch4	Ch5	Ch6	Ch7	Ch8
Rotational angle error (degree)	0.1	0.9	1.1	0.9	1.6	1.2	0.8	0.2
PER (dB)	24.3	25.8	25.1	22.8	25.1	24.2	24.7	24.7

Figure 17 shows the optical fiber-coupled power characteristics of the TOSA and the ELS at the TOSA case temperature of 55°C and the housing temperature of 55°C. The curve for the QSFP ELS is very slightly lower than that of the TOSA because the LD temperature is only 0.7°C higher. The fiber-coupled power of the TOSA is in good agreement with that of the ELS. It can be considered that the TOSA case temperature increase is suppressed in the housing well as the thermal simulation.

Figure 18 shows calculated and measured power consumption as a function of LD bias current for the pigtailed-QSFP ELS. The calculated characteristic is shown with a dotted line and the measured results is shown with open circle plots. As can be seen from the graph, the measured result has a good agreement with the calculated result. When all LDs are driven at an LD bias current of 300 mA to obtain the optical fiber-coupled power of >100 mW at a housing temperature of 55°C, the power consumption of the ELS measures 5.6 W. Accordingly, PCE is calculated as high as the record PCE of 14.3%, and is realized.

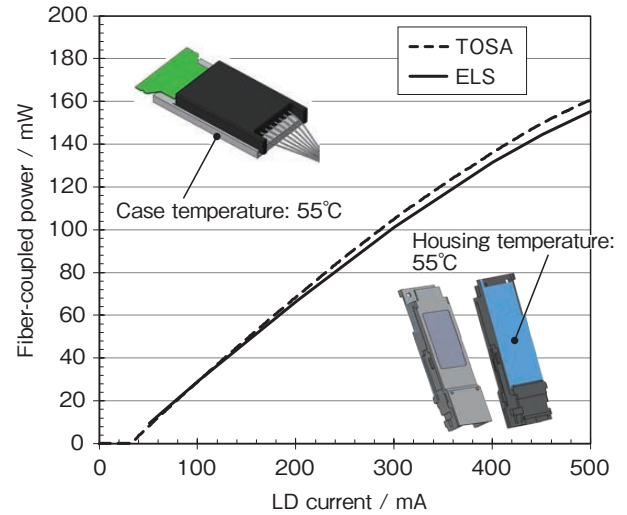

Figure 17 Optical power as a function of LD bias current for the TOSA and the pigtailed-QSFP ELS.

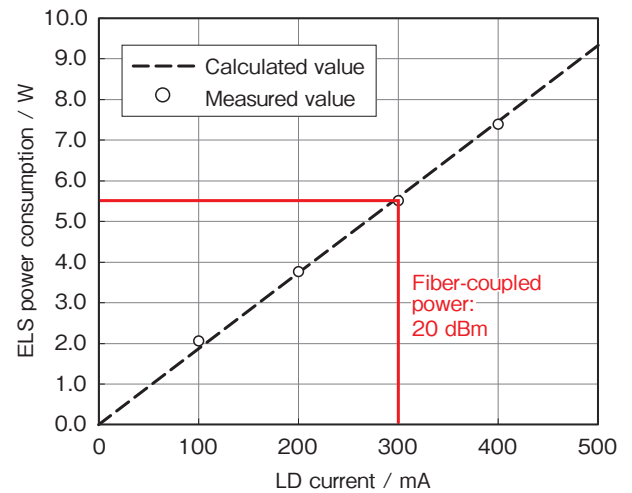

Figure 18 Calculated and measured power consumption as a function of LD bias current for the pigtailed-QSFP ELS.

7. CONCLUSION

We designed and fabricated the uncooled 8-channel TOSA which integrates our high-power DFB laser diodes. The size of TOSA is as small as 22.5 mm (L) x 13.0 mm (W) x 4.0 mm (H) and it can be built together with control circuitries into the various housings proposed for an ELS. In addition, with the heat dissipation structure to suppress the laser temperature increase and the optical system to obtain high coupling efficiency, TOSA achieved fiber-coupled optical power >20 dBm for all channels at power consumption of as low as 3.7 W at the TOSA case temperature of 55°C and the power conversion efficiency is as high as 21.2% .

Furthermore, we designed and fabricated the CPO ELS module employing a QSFP which is the smallest among the housings proposed for an ELS. With power-saving control circuitries and internal structure which has low thermal resistance between TOSA and a QSFP housing, the ELS module achieved total power consumption of as

low as 5.6 W at the fiber coupled optical power of 20 dBm for all channels and the housing temperature of 55°C, accordingly PCE of as high as 14.3% is achieved. The MPO connector is assembled with a precise angle alignment of slow axis of PMFs, and measured PER numbers are as high as >20 dB for all channels.

REFERENCES

- 1) Broadcom News Release: “Broadcom Ships Tomahawk 5, Industry’s Highest Bandwidth Switch Chip to Accelerate AI/ML Workloads”, Aug. 2022. [Online] Available: <https://www.broadcom.com/company/news/product-releases/60456>
- 2) CPO Collaboration: “Co-packaged Optics External Laser Source Guidance Document”, Version 1.0, Jan. 2020.
- 3) Optical Internetworking Forum: “External Laser Small Form Factor Pluggable (ELSFP) Implementation Agreement”, OIFELSFP-01.0, Aug. 2023.
- 4) J. E. Johnson, K. Bacher, R. Schaevitz, and V. Raghunathan: “Performance and Reliability of Advanced CW Lasers for Silicon Photonics Applications”, Optical Fiber Communication Conference 2022, TuD.1, Mar. 2022.
- 5) Furukawa Electric HP > News Release > "Mass production of a high output 100mW DFB laser diode chip" (Released date: September 25, 2023, Referred on Dec. 20, 2024)
[Online] Available: https://www.furukawa.co.jp/en/release/2023/comm_20230925.html
- 6) CWDM4 MSA: “ 100G CWDM4 MSA Technical Specifications”, Rev. 1.0, Aug. 2014.